

Megacity Apartments Pvt. Ltd.
Authorized Signatory

दिशारी अवकाश

राष्ट्रमण्डिर शरणे

Sarbanandapur, Bolpur, Shantiniketan, Birbhum, West Bengal

www.deeshariabokash.co.in



প্রতি
SITE PLAN

Megacity Apartments Pvt. Ltd.
Authorised Signatory

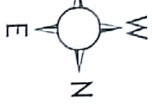

পদক্ষেপে আবিষ্কার

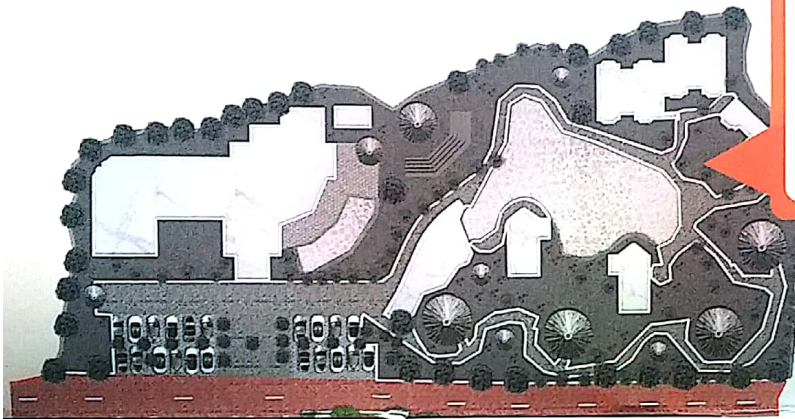
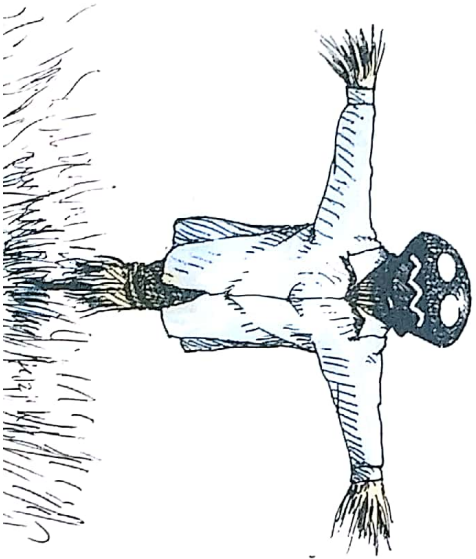

- 01 STUDIO APARTMENT
- 02 1BHK APARTMENT
- 03 2BHK APARTMENT
- 04 ROW HOUSE
- 05 QUADRA HOUSE
- 06 SINGLE COTTAGE



Megacity Apartments Pvt. Ltd.
Authorised Signatory

সোনার তরী (SONAR TORI) STUDIO APARTMENT

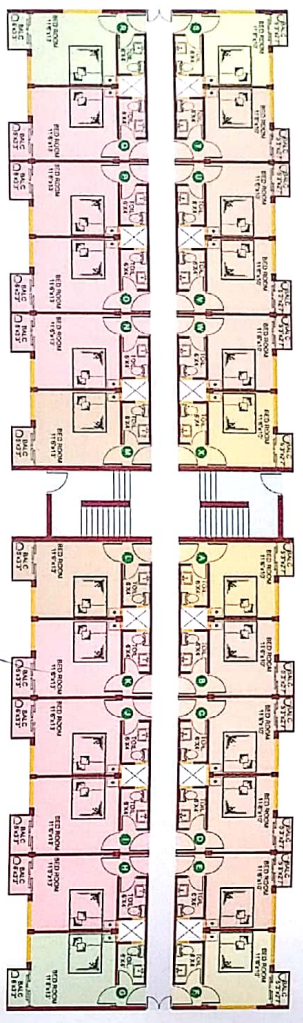

GROUND, FIRST & SECOND FLOOR PLAN

Megacity Apartments Pvt. Ltd.
 Authorised Signatory



TYPE	AREA STATEMENT	
	Covered Area	Saleable Area
A, X	201	289
B, C, D, E, T, U, V, W	190	271
F, S	198	282
G, R	241	344
H, I, J, K, N, O, P, Q	231	330
L, M	245	350

ক্ষেয়া (KHEYA) 1 BHK APARTMENT

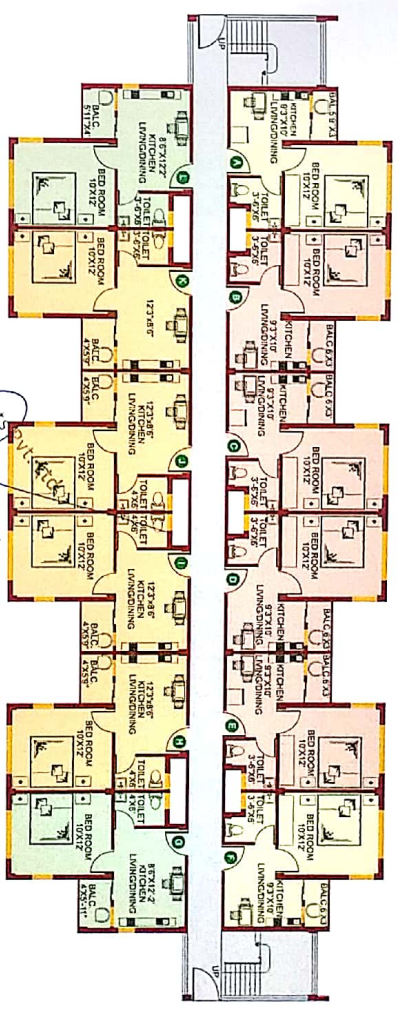

GROUND, FIRST & SECOND FLOOR PLAN

Megacity Apartments Pvt. Ltd.
 Authorised Signatory

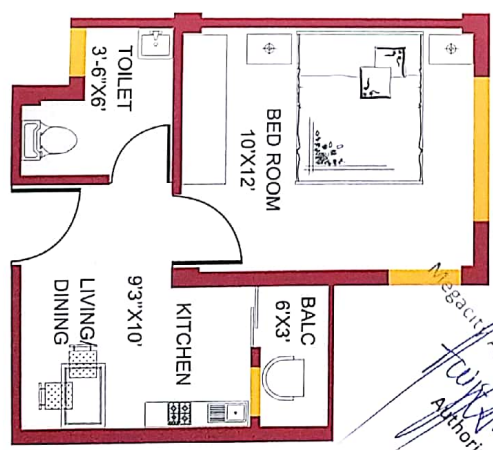

TYPE	AREA STATEMENT	
	Covered Area	Saleable Area
A, F	290	417
B, C, D, E	287	412
G, L	318	457
H, I, J, K	313	450



রক্ত করবি (RAKTA KARABI) 2 BHK APARTMENT

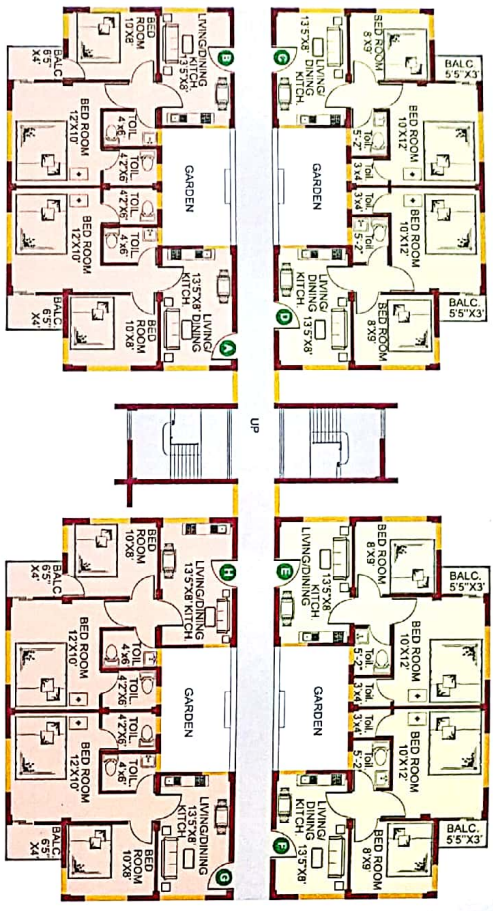

GROUND, FIRST & SECOND FLOOR PLAN

AREA STATEMENT	
TYPE	AREA (Sq. ft)
A, B, G & H	Covered Area 470.0
C, D, E & F	Saleable Area 685
	Megacity Apartments Pvt. Ltd. Saleable Area 620

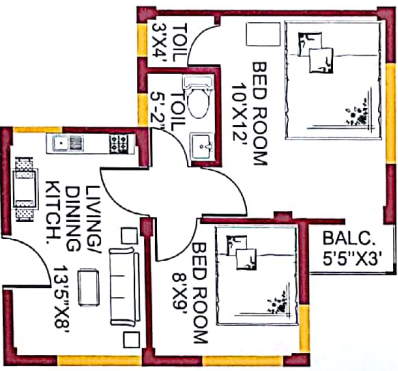

ROW HOUSES

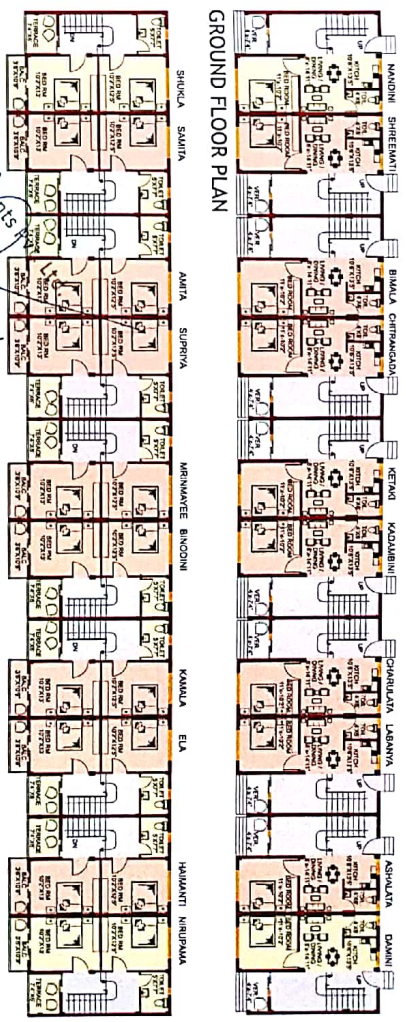

FIRST FLOOR PLAN

AREA STATEMENT	
TYPE	AREA (Sq. ft)
Nandini, Damini, Nirupama & Shukla	Covered Area 1061
Shreemati, Bimala, Chitrangada Ketaki, Kadambini, Charulata Labanya, Ashlata, Haimanti, Ela, Kamala, Binodini, Mrimayee Supriya, Amita & Samita	Saleable Area 1273
	1044
	1253

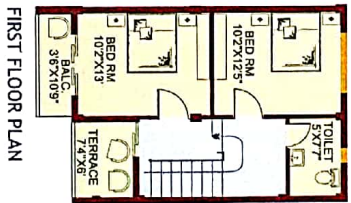
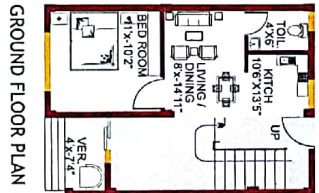

QUADRA HOUSES

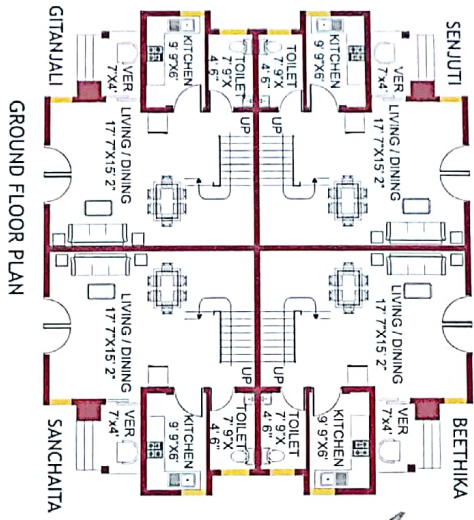

Megacity Apartments Pvt. Ltd.
 Authorised Signatory



AREA STATEMENT	
TYPE	AREA (Sq. ft)
Covered Area	1015
Saleable Area	1218

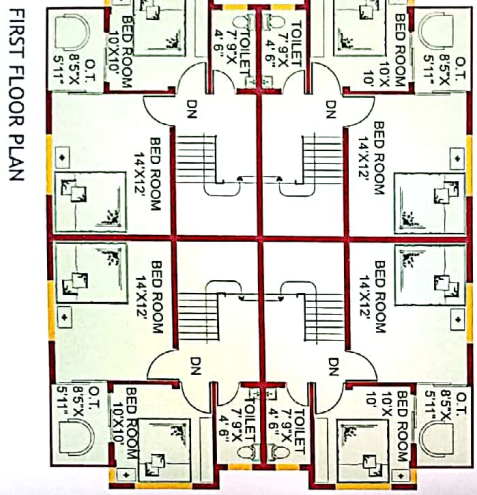

FIRST FLOOR PLAN

କଥା (KATHA) ଓ କାହିନୀ (KAHINI) SINGLE COTTAGE

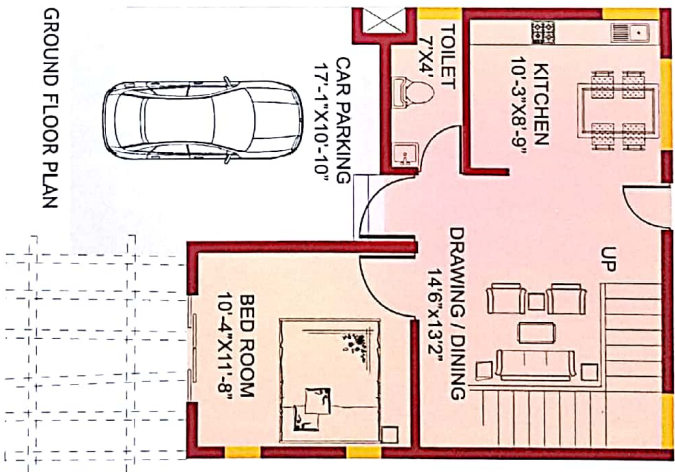

GROUND FLOOR PLAN

AREA STATEMENT	
TYPE	AREA (Sq. ft)
Covered Area	1403
Saleable Area	1684

Katha, Kahani

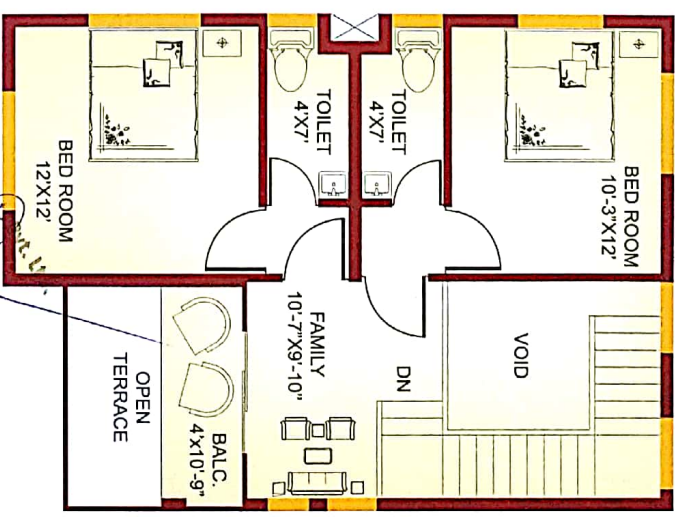

FIRST FLOOR PLAN

Megacity Apartments Pvt. Ltd.
 Authorised Signatory



পথ চলাতেই আনন্দ
LOCATION MAP

KANKALITALA TO SITE : 01.0 KM
PRANTIK TO SITE : 03.5 KM
BISWABHARATI TO SITE : 06.0 KM
BOLPUR BUS STAND TO SITE : 08.0 KM
BOLPUR RLY. STATION TO SITE : 10.0 KM

Megacity Apartments Pvt. Ltd.
[Signature]
Authorised Signatory

