

# REPORT ON SOIL INVESTIGATION

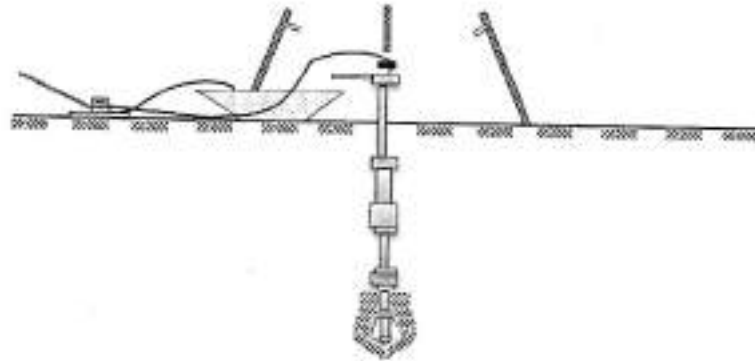

## **-: NAME OF WORK:-**

**CONSTRUCTION OF PROPOSED  
BASEMENT + LOWER GROUND + SIX STORIED COMMERCIAL  
CUM MULTIPLEX BUILDING  
AT GANGANAGAR, BURDWAN ROAD, WARD NO-5 (SMC),  
P.S.-SILIGURI, DIST-DARJEELING**

**LOCATION AT: -BURDWAN ROAD, SILIGURI,  
MOUZA SILIGURI, J.L.NO. 110(88), KHATIAN NO 180/1, 182, 1142, 1143  
PLOT NO- 2143, 2155, 2156, 2159  
P.O. SILIGURI, P.S. SILIGURI DIST.- DARJEELING**

## **CLIENT: -**

- 1. SRI NARESH AGARWAL, S/O LATE. KAILASH CHAND AGARWAL**
- 2. SMT. ANSHU AGARAWAL, W/O SRI NARESH AGARWAL**
- 3. PRM REAL ESTATE PVT. LTD. REPRESENTED BY ITS DIRECTOR  
SRI PREM KUMAR. AGARWAL, S/O LATE. GANGADHAR AGARWAL**
- 4. SRI. VIJAY KUMAR. SHAH, S/O LATE DIN DAYAL SHAH.**

## **INVESTIGATOR**





**Surajit Chatterjee**  
B.E. (CIVIL), M.I.E.  
Chartered Engineer  
Geo-Technical Engineer, Class-I  
SMC empanement Number-07  
Hospital More, Near Children Park  
Siliguri-734001, Ph-9434020002  
E-mail: chatterjee\_cbe@yahoo.co.in

## **ACHARYA ASSOCIATES**

GEO-TECHNICAL, SOIL INVESTIGATION, MATERIAL TESTING SURVEYING  
(DIGITAL), PLANNING AND ESTIMATING  
35, DINABANDHU MITRA SARANI, SUBHASPALLY, SILIGURI.  
DIST- DARJEELING, Pin-734001  
CELL-9851173583/94340-48977/9832375155  
Email- acharyamainak@gmail.com



## CONTENTS

Sl. No.	Description	Pages
01	Introduction and scope	02-02
02	Detail of Soil Investigations	03-05
03	Site plan	06-06
04	Bore-log Data sheet ( Tab-1 to 7)	07-13
05	Grain Size analysis	14-20
06	Estimated Physical Properties of soil (Tab-8)	21-21
07	Correction of field SPT (N) Value (Tab-9)	22-22
08	Calculation of Net safe Bearing Capacity for General Shear Failure(Tab-10)	23-23
09	Calculation of Net safe Bearing Capacity for Local Shear Failure (Tab-11)	24-24
10	Summary Table of calculation of Net Safe Bearing Capacities based on Shear Failure and Settlement criteria as per Codal Provisions based on which Suggested Net Safe Bearing Capacity has been recommended.(Tab-12)	25-25
11	Photography	26-28



---

## **INTRODUCTION AND SCOPE :**

Soil investigation has been carried out at Ganganagar, Burdwan Road, Ward No-5(SMC), P.S.-Siliguri, and Dist-Darjeeling for the purpose of designing suitable foundation for Basement +Lower Ground + six Storied Commercial cum multiplex Building.

The objective of the exploration work was to determine the probable sub surface conditions such as stratification, denseness or hardness of the strata, position of ground water table etc. and to evaluate probable range of safe bearing capacity for preparing safe and economic design of foundation.

The plot is more or less level and the Spot is 0.50m above from existing road level. Seven 150 mm dia bore holes were taken down to a depth of 15 m below the existing ground level at the site as per location shown in the site plan. Auger boring and bentonite mud drilling were used for drilling the holes. Standard Penetration Test was done on the soil at different depth.

Laboratory testing on selected undisturbed/representative soil samples were done for classification purpose and to determine their strength & other physical properties.



---

**THE FOLLOWING TESTS WERE ONE FOR DETAILS SOIL INVESTIGATION :-**

**(A) FIELD TESTS:**

1. Standard penetration tests,
2. Determination of In-Situ density,

**(B) LABORATORY TESTS:**

1. Natural moisture content
2. Specific Gravity
3. Grain size analysis,

**1. Standard Penetration Tests :-**

A standard split spoon sampler is driven 45 cm into the ground by means of a 63.5 kg hammer falling freely from a height of 75 cm. The total number of blows required to drive the second and third depth of 15 cm ( i.e. total 30 cm ) is called the standard Penetration resistance ( N blows per 30 cm). After the blow counts are recorded, the spoon is withdrawn and a representative sample is obtained for identification tests. The N value has been corrected as per IS: 2123-1981.

**Corrections:**

- a) Due to Overburden - The N value for cohesionless soil shall be corrected for overburden ( $N'$ ).
- b) Due to Dilatancy - The value obtained after correction due to overburden shall be corrected for dilatancy if the stratum consists of fine sand and silt below water table for values of  $N'$  greater than 15, as under ( $N''$ ):

$$N'' = 15 + \frac{1}{2} ( N' - 15 )$$

**2. Determination of In-Situ density:**

The in-situ density of soil is determined by core cutter method as per IS: 2720 (Part XXIX) - 1975.



---

## **(B) LABORATORY TESTS:**

The soil samples collected from the bore holes during field Investigation were sent to the laboratory for determination of soil classification and physical properties.

The following laboratory tests were conducted on soil sample.

1. **Natural moisture content:** It is the ratio of weight of water in the voids to the weight of solids. It is expressed as percentage.

It is determined in the laboratory by Oven drying method as per IS: 2720 (Part-II)-1973. In this method the soil sample (collected in the air tight polythene pack) is dried in thermostatically controlled oven at 105-110°C for 24 hours.

2. **Specific Gravity:** Specific gravity is the ratio of the weight in air of a given volume of a material at a standard temperature to the weight in air of an equal volume of distilled water at the same stated temperature.

The specific gravity of soil sample is determined by density bottle method as per IS: 2720 (Part III/Sec 1) - 1980.

### **3. Shear Strength test:**

When an external load is applied on a soil mass, shearing stresses are induced in it. If the shear stress developed on any plane in the soil exceeds a certain limiting value, failure of the soil occurs.

The maximum shear stress which a given soil can withstand is called its shear strength.

The factors governing the shear strength of a soil are:

- (a) Internal friction.
- (b) Cohesion.

As it is seen from two no's bore log data sheet that the average soil strata at 2 to 4 m is fine, medium & coarse sand, which is **cohesionless(C=0)**, so **shear parameter angle of internal friction ( $\phi$ )** is found out from **correlation between angle of internal friction and corrected SPT value as per IS 6403 : 1981.**



---

Unconfined Compression test and Vane Shear test is applicable for pure forms of clay.

2. **Grain size analysis :**

The soil samples collected from the different depths were used for determination of Grain Size analysis. This is determined in the laboratory by the mechanical analysis, which consists of:

(a) **Dry mechanical analysis or sieve analysis.**[IS-2720 (Part-4)- 1985]

(b) Wet mechanical analysis or hydrometer analysis. [IS-2720 (Part-4)- 1985]

**Determination of Net Safe Bearing Capacity of Soil:**

Net Safe Bearing capacity of soil is determined considering the following two aspects :

1. **Shear failure of soil as per IS:6403-1981:** Under this aspect calculations are made for both General Shear failure and Local Shear failure and appropriate value of the either, or a interpolated value as per void ratio is determined as the net safe bearing capacity from shear failure point of view.

2. **Allowable settlements as per IS: 8009 (Part-1)-1986:** Maximum permissible settlement for R.C.C. structure and the type of soil as mentioned in the report(sandy) is 50mm as per IS: 8009 (Part-1)-1986. In the present case considering all aspects, allowable settlement as indicated in the Net allowable bearing capacity Table has been assumed to determine the Net Safe bearing capacity by the formula suggested by Bowles(1988):

$$\text{Net Safe Bearing Capacity} = 48N_{cor}R_d((B+.33)/2)^2S_aR_w$$

Where

$N_{cor}$  = Design N(SPT) Value

$S_a$  = Allowable Settlement

$R_d$  = Depth Correction Factor =

$B$  = Width of Footing

$R_w$  = Water Table Correction

The **Net allowable bearing capacity** is taken as the lesser of the two values determined considering the above two aspects.

The calculations are shown in table- 8,9,10,11 &12



**SITE PLAN SHOWING THE BOREHOLE LOCATION FOR PROPOSED  
BASEMENT +LOWER GROUND +SIX STORED COMMERCIAL CUM MULTIPLEX BUILDING**

**LAND OWNERS :-**  
 1) SRI NARESH AGARWAL, S/O. LATE KAILASH CHAND AGARWAL  
 2) SMT. ANSHU AGARWAL, W/O. SRI NARESH AGARWAL  
 3) PRM REAL ESTATE PRIVATE LIMITED  
 REPRESENTED BY ITS DIRECTOR,  
 SRI PREM KUMAR AGARWAL, S/O. LATE GANGADHAR AGARWAL.  
 4) SRI VIJAY KUMAR SHAH, S/O. LATE DINDAYAL SHAH.

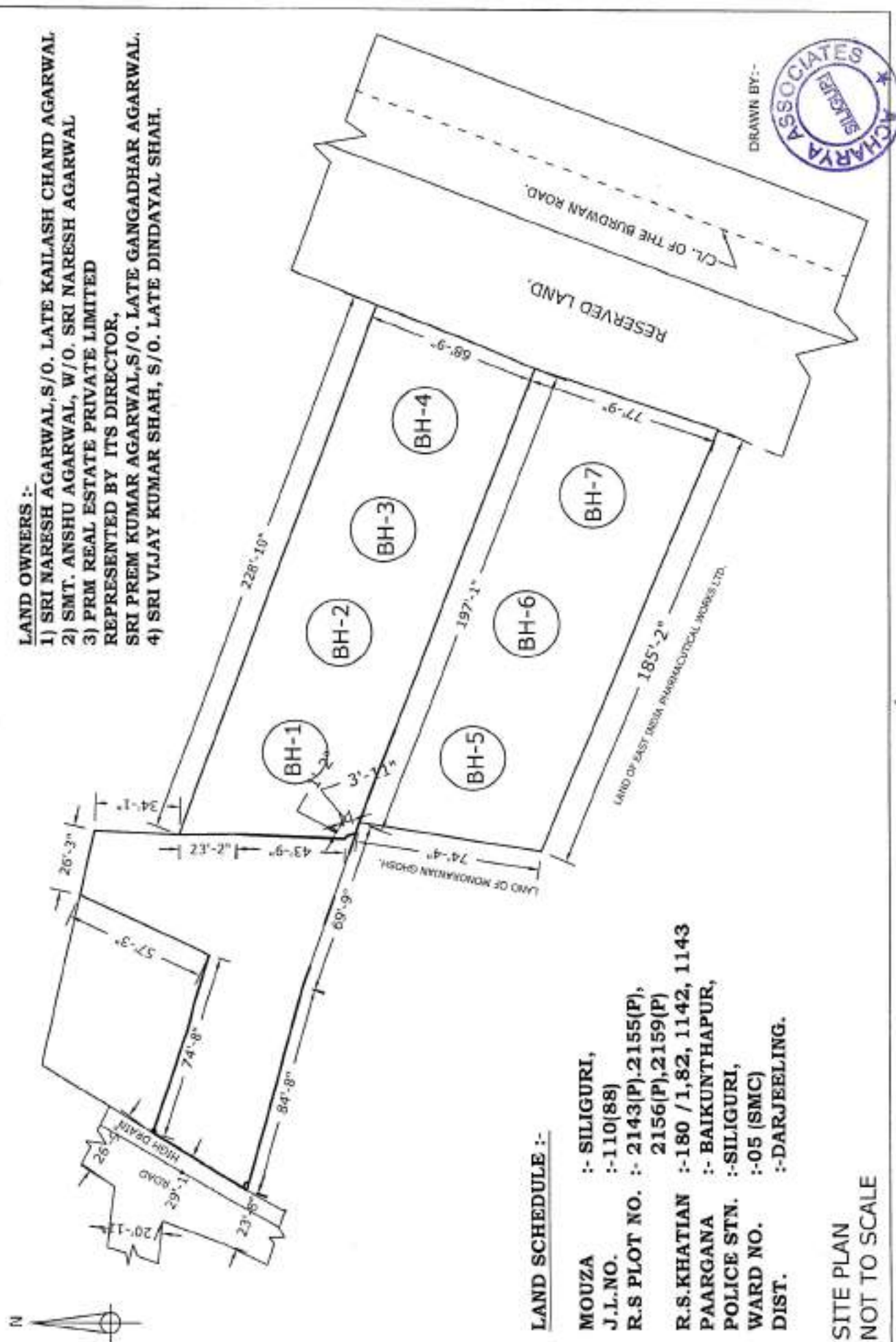











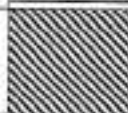

**LAND SCHEDULE :-**

**MOUZA :-** SILIGURI,  
**J.L.NO.** :- 110(88)  
**R.S PLOT NO.** :- 2143(P), 2155(P),  
 2156(P), 2159(P)  
**R.S.KHATIAN** :- 180 / 1, 82, 1142, 1143  
**PAARGANA** :- BAIKUNTHAPUR,  
**POLICE STN.** :- SILIGURI,  
**WARD NO.** :- 05 (SMC)  
**DIST.** :- DARJEELING.

**SITE PLAN  
 NOT TO SCALE**



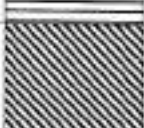









**Table-1**  
**BORE LOG DATA SHEET**

TYPE OF BORING	SHELL & AUGER	TYPE OF DRILLING			BORE HOLE NO. 1			
DIA OF BORE	150 MM	BMD			GROUND/ BED RL	The spot is 0.50 m above from road level.		
TERMINATION DEPTH	15.00 m			LOCATION				
COMMENCED ON : 22/10/2018	COMPLETED ON : 24/10/2018			GANGANAGAR, BURDWAN ROAD, WARD NO-5, P.S.- SILIGURI, DIST-DARJEELING.				
GROUND WATER LEVEL	2.7 M Down from G.L							
DESCRIPTION OF STRATA	LEGEND	FROM	TO	Thickness	N	SAMPLES		DEPTH
		m	m	m	Value	Type	Ref. No.	m
Silty fine, medium, Course sand with Gravel grey in colour.		2.00	2.45	0.45	17	P	P-II/1	2.15-2.45
Do		3.00	3.45	0.45	15	P	P-II/2	3.15-3.45
Do		4.00	4.45	0.45	24	P	P-II/3	4.15-4.45
Silty fine, medium, Course sand with Gravel grey in colour.		5.00	5.45	0.45	25	P	P-II/4	5.15-5.45
Do		6.00	6.45	0.45	18	P	P-II/5	6.15-6.45
Do		7.00	7.45	0.45	22	P	P-II/6	7.15-7.45
Do		8.00	8.45	0.45	27	P	P-II/7	8.15-8.45
Silty fine, medium, Course sand with Gravel grey in colour.		9.00	9.45	0.45	26	P	P-II/8	9.15-9.45
Do		10.00	10.45	0.45	38	P	P-II/9	10.15-10.45
Do		11.00	11.45	0.45	40	P	P-II/10	11.15-11.45
Do		12.00	12.45	0.45	50	P	P-II/11	12.15-12.45
Do		13.00	13.45	0.45	65	P	P-II/12	13.15-13.45
Do		14.00	14.45	0.45	100	P	P-II/13	14.15-14.45
Code : U-Undisturbed sample, D – Disturbed Sample, L – Large Diameter, C – Core W-Water Sample, P-Penetration. Test, V – Vane Shear Test								
No. of disturbed Sample : NIL			No. of UDS : NIL			No. of Vane Test : NIL		
No. of Large Diameter Sample : NIL			No. of S.P.T. : Seven (07)			No. of Water Sample : NIL		











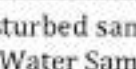
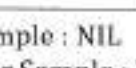
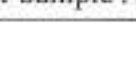



**Table-2**  
**BORE LOG DATA SHEET**

TYPE OF BORING		SHELL & AUGER		TYPE OF DRILLING		BORE HOLE NO. 2		
DIA OF BORE		150 MM		BMD		GROUND/ BED RL		The spot is 0.50 m above from road level.
TERMINATION DEPTH		15.00 m		LOCATION			GANGANAGAR, BURDWAN ROAD, WARD NO-5, P.S.- SILIGURI, DIST-DARJEELING.	
COMMENCED ON : 22/10/2018		COMPLETED ON : 24/10/2018		GROUND WATER LEVEL		2.7 M Down from G.L		
DESCRIPTION OF STRATA	LEGEND	FROM	TO	Thickness	N	SAMPLES		DEPTH
		m	m	m	Value	Type	Ref. No.	M
Silty fine, medium, Course sand with Gravel grey in colour.		2.00	2.45	0.45	14	P	P-II/1	2.15-2.45
Do		3.00	3.45	0.45	20	P	P-II/2	3.15-3.45
Do		4.00	4.45	0.45	22	P	P-II/3	4.15-4.45
Silty fine, medium, Course sand with Gravel grey in colour.		5.00	5.45	0.45	21	P	P-II/4	5.15-5.45
Do		6.00	6.45	0.45	16	P	P-II/5	6.15-6.45
Do		7.00	7.45	0.45	18	P	P-II/6	7.15-7.45
Do		8.00	8.45	0.45	24	P	P-II/7	8.15-8.45
Silty fine, medium, Course sand with Gravel grey in colour.		9.00	9.45	0.45	21	P	P-II/8	9.15-9.45
Do		10.00	10.45	0.45	37	P	P-II/9	10.15-10.45
Do		11.00	11.45	0.45	38	P	P-II/10	11.15-11.45
Do		12.00	12.45	0.45	46	P	P-II/11	12.15-12.45
Do		13.00	13.45	0.45	52	P	P-II/12	13.15-13.45
Do		14.00	14.45	0.45	120	P	P-II/13	14.15-14.45
Code : U-Undisturbed sample, D - Disturbed Sample, L - Large Diameter, C - Core W-Water Sample, P-Penetration. Test, V - Vane Shear Test								
No. of disturbed Sample : NIL			No. of UDS : NIL			No. of Vane Test : NIL		
No. of Large Diameter Sample : NIL			No. of S.P.T. : Seven (07)			No. of Water Sample : NIL		













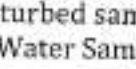

**Table-3****BORE LOG DATA SHEET**

TYPE OF BORING		SHELL & AUGER		TYPE OF DRILLING		BORE HOLE NO. 3			
DIA OF BORE		150 MM		BMD		GROUND/ BED RL		The spot is 0.50 m above from road level.	
TERMINATION DEPTH		15.00 m						LOCATION	
COMMENCED ON : 22/10/2018			COMPLETED ON : 24/10/2018			GANGANAGAR, BURDWAN ROAD, WARD NO-5, P.S.- SILIGURI, DIST-DARJEELING.			
GROUND WATER LEVEL		2.7 M Down from G.L							
DESCRIPTION OF STRATA	LEGEND	FROM	TO	Thickness	N	SAMPLES		DEPTH	
		m	m	m	Value	Type	Ref. No.	M	
Silty fine, medium, Course sand with Gravel grey in colour.		2.00	2.45	0.45	13	P	P-II/1	2.15-2.45	
Do		3.00	3.45	0.45	22	P	P-II/2	3.15-3.45	
Do		4.00	4.45	0.45	20	P	P-II/3	4.15-4.45	
Silty fine, medium, Course sand with Gravel grey in colour.		5.00	5.45	0.45	19	P	P-II/4	5.15-5.45	
Do		6.00	6.45	0.45	13	P	P-II/5	6.15-6.45	
Do		7.00	7.45	0.45	19	P	P-II/6	7.15-7.45	
Do		8.00	8.45	0.45	25	P	P-II/7	8.15-8.45	
Silty fine, medium, Course sand with Gravel grey in colour.		9.00	9.45	0.45	21	P	P-II/8	9.15-9.45	
Do		10.00	10.45	0.45	39	P	P-II/9	10.15-10.45	
Do		11.00	11.45	0.45	40	P	P-II/10	11.15-11.45	
Do		12.00	12.45	0.45	43	P	P-II/11	12.15-12.45	
Do		13.00	13.45	0.45	65	P	P-II/12	13.15-13.45	
		14.00	14.45	0.45	120	P	P-II/13	14.15-14.45	
Code : U-Undisturbed sample, D - Disturbed Sample, L - Large Diameter, C - Core W-Water Sample, P-Penetration. Test, V - Vane Shear Test									
No. of disturbed Sample : NIL			No. of UDS : NIL			No. of Vane Test : NIL			
No. of Large Diameter Sample : NIL			No. of S.P.T. : Seven (07)			No. of Water Sample : NIL			















**Table-4**  
**BORE LOG DATA SHEET**

TYPE OF BORING		SHELL & AUGER		TYPE OF DRILLING		BORE HOLE NO. 4			
DIA OF BORE		150 MM		BMD		GROUND/ BED RL		The spot is 0.50 m above from road level.	
TERMINATION DEPTH		15.00 m						LOCATION	
COMMENCED ON : 22/10/2018			COMPLETED ON : 24/10/2018			GANGANAGAR, BURDWAN ROAD, WARD NO-5, P.S.- SILIGURI, DIST-DARJEELING.			
GROUND WATER LEVEL			2.7 M Down from G.L.						
DESCRIPTION OF STRATA	LEGEND	FROM	TO	Thickness	N	SAMPLES		DEPTH	
		m	m	m	Value	Type	Ref. No.	M	
Silty fine, medium, Course sand with Gravel grey in colour.		2.00	2.45	0.45	15	P	P-II/1	2.15-2.45	
Do		3.00	3.45	0.45	23	P	P-II/2	3.15-3.45	
Do		4.00	4.45	0.45	17	P	P-II/3	4.15-4.45	
Silty fine, medium, Course sand with Gravel grey in colour.		5.00	5.45	0.45	18	P	P-II/4	5.15-5.45	
Do		6.00	6.45	0.45	11	P	P-II/5	6.15-6.45	
Do		7.00	7.45	0.45	22	P	P-II/6	7.15-7.45	
Do		8.00	8.45	0.45	27	P	P-II/7	8.15-8.45	
Silty fine, medium, Course sand with Gravel grey in colour.		9.00	9.45	0.45	23	P	P-II/8	9.15-9.45	
Do		10.00	10.45	0.45	41	P	P-II/9	10.15-10.45	
Do		11.00	11.45	0.45	53	P	P-II/10	11.15-11.45	
Do		12.00	12.45	0.45	56	P	P-II/11	12.15-12.45	
Do		13.00	13.45	0.45	61	P	P-II/12	13.15-13.45	
Do		14.00	14.45	0.45	160	P	P-II/13	14.15-14.45	
Code : U-Undisturbed sample, D - Disturbed Sample, L - Large Diameter, C - Core W-Water Sample, P-Penetration. Test, V - Vane Shear Test									
No. of disturbed Sample : NIL			No. of UDS : NIL			No. of Vane Test : NIL			
No. of Large Diameter Sample : NIL			No. of S.P.T. : Seven (07)			No. of Water Sample : NIL			









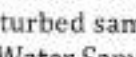
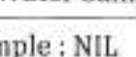
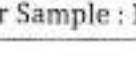



**Table-5**  
**BORE LOG DATA SHEET**

TYPE OF BORING		SHELL & AUGER		TYPE OF DRILLING		BORE HOLE NO. 5		
DIA OF BORE		150 MM		BMD		GROUND/ BED RL		The spot is 0.50 m above from road level.
TERMINATION DEPTH		15.00 m		LOCATION			GANGANAGAR, BURDWAN ROAD, WARD NO-5, P.S.- SILIGURI, DIST-DARJEELING.	
COMMENCED ON : 22/10/2018		COMPLETED ON : 24/10/2018		GROUND WATER LEVEL		2.7 M Down from G.L		
DESCRIPTION OF STRATA	LEGEND	FROM	TO	Thickness	N	SAMPLES		DEPTH
		m	m	m	Value	Type	Ref. No.	M
Silty fine, medium, Course sand with Gravel grey in colour.		2.00	2.45	0.45	19	P	P-II/1	2.15-2.45
Do		3.00	3.45	0.45	17	P	P-II/2	3.15-3.45
Do		4.00	4.45	0.45	15	P	P-II/3	4.15-4.45
Silty fine, medium, Course sand with Gravel grey in colour.		5.00	5.45	0.45	14	P	P-II/4	5.15-5.45
Do		6.00	6.45	0.45	10	P	P-II/5	6.15-6.45
Do		7.00	7.45	0.45	13	P	P-II/6	7.15-7.45
Do		8.00	8.45	0.45	21	P	P-II/7	8.15-8.45
Silty fine, medium, Course sand with Gravel grey in colour.		9.00	9.45	0.45	25	P	P-II/8	9.15-9.45
Do		10.00	10.45	0.45	88	P	P-II/9	10.15-10.45
Do		11.00	11.45	0.45	50	P	P-II/10	11.15-11.45
Do		12.00	12.45	0.45	54	P	P-II/11	12.15-12.45
Do		13.00	13.45	0.45	70	P	P-II/12	13.15-13.45
Do		14.00	14.45	0.45	110	P	P-II/13	14.15-14.45
Code : U-Undisturbed sample, D - Disturbed Sample, L - Large Diameter, C - Core W-Water Sample, P-Penetration. Test, V - Vane Shear Test								
No. of disturbed Sample : NIL			No. of UDS : NIL			No. of Vane Test : NIL		
No. of Large Diameter Sample : NIL			No. of S.P.T. : Seven (07)			No. of Water Sample : NIL		





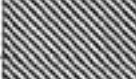





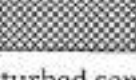
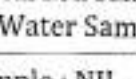

**Table-6**  
**BORE LOG DATA SHEET**

TYPE OF BORING	SHELL & AUGER	TYPE OF DRILLING		BORE HOLE NO. 6				
DIA OF BORE	150 MM	BMD		GROUND/ BED RL	The spot is 0.50 m above from road level.			
TERMINATION DEPTH	15.00 m			LOCATION				
COMMENCED ON : 22/10/2018	COMPLETED ON : 24/10/2018			GANGANAGAR, BURDWAN ROAD, WARD NO-5, P.S.- SILIGURI, DIST-DARJEELING.				
GROUND WATER LEVEL	2.7 M Down from G.L							
DESCRIPTION OF STRATA	LEGEND	FROM	TO	Thickness	N	SAMPLES		DEPTH
		m	m	m	Value	Type	Ref. No.	M
Silty fine, medium, Course sand with Gravel grey in colour.		2.00	2.45	0.45	32	P	P-II/1	2.15-2.45
Do		3.00	3.45	0.45	28	P	P-II/2	3.15-3.45
Do		4.00	4.45	0.45	32	P	P-II/3	4.15-4.45
Silty fine, medium, Course sand with Gravel grey in colour.		5.00	5.45	0.45	26	P	P-II/4	5.15-5.45
Do		6.00	6.45	0.45	20	P	P-II/5	6.15-6.45
Do		7.00	7.45	0.45	30	P	P-II/6	7.15-7.45
Do		8.00	8.45	0.45	40	P	P-II/7	8.15-8.45
Silty fine, medium, Course sand with Gravel grey in colour.		9.00	9.45	0.45	50	P	P-II/8	9.15-9.45
Do		10.00	10.45	0.45	88	P	P-II/9	10.15-10.45
Do		11.00	11.45	0.45	56	P	P-II/10	11.15-11.45
Do		12.00	12.45	0.45	65	P	P-II/11	12.15-12.45
Do		13.00	13.45	0.45	80	P	P-II/12	13.15-13.45
Do		14.00	14.45	0.45	130	P	P-II/13	14.15-14.45
Code : U-Undisturbed sample, D - Disturbed Sample, L - Large Diameter, C - Core W-Water Sample, P-Penetration. Test, V - Vane Shear Test								
No. of disturbed Sample : NIL			No. of UDS : NIL			No. of Vane Test : NIL		
No. of Large Diameter Sample : NIL			No. of S.P.T. : Seven (07)			No. of Water Sample : NIL		



**Table-7**  
**BORE LOG DATA SHEET**

TYPE OF BORING	SHELL & AUGER	TYPE OF DRILLING		BORE HOLE NO. 7				
DIA OF BORE	150 MM	BMD		GROUND/ BED RL	The spot is 0.50 m above from road level.			
TERMINATION DEPTH	15.00 m			LOCATION				
COMMENCED ON : 22/10/2018	COMPLETED ON : 24/10/2018			GANGANAGAR, BURDWAN ROAD, WARD NO-5, P.S.- SILIGURI, DIST-DARJEELING.				
GROUND WATER LEVEL	2.7 M Down from G.L							
DESCRIPTION OF STRATA	LEGEND	FROM	TO	Thickness	N	SAMPLES		DEPTH
		m	m	m	Value	Type	Ref. No.	M
Silty fine, medium, Course sand with Gravel grey in colour.		2.00	2.45	0.45	17	P	P-II/1	2.15-2.45
Do		3.00	3.45	0.45	25	P	P-II/2	3.15-3.45
Do		4.00	4.45	0.45	18	P	P-II/3	4.15-4.45
Silty fine, medium, Course sand with Gravel grey in colour.		5.00	5.45	0.45	20	P	P-II/4	5.15-5.45
Do		6.00	6.45	0.45	13	P	P-II/5	6.15-6.45
Do		7.00	7.45	0.45	25	P	P-II/6	7.15-7.45
Do		8.00	8.45	0.45	30	P	P-II/7	8.15-8.45
Silty fine, medium, Course sand with Gravel grey in colour.		9.00	9.45	0.45	25	P	P-II/8	9.15-9.45
Do		10.00	10.45	0.45	44	P	P-II/9	10.15-10.45
Do		11.00	11.45	0.45	60	P	P-II/10	11.15-11.45
Do		12.00	12.45	0.45	70	P	P-II/11	12.15-12.45
		13.00	13.45	0.45	85	P	P-II/12	13.15-13.45
		14.00	14.45	0.45	125	P	P-II/13	14.15-14.45
Code : U-Undisturbed sample, D - Disturbed Sample, L - Large Diameter, C - Core W-Water Sample, P-Penetration. Test, V - Vane Shear Test								
No. of disturbed Sample : NIL			No. of UDS : NIL			No. of Vane Test : NIL		
No. of Large Diameter Sample : NIL			No. of S.P.T. : Seven (07)			No. of Water Sample : NIL		



**GRAIN SIZE ANALYSIS OF BORE HOLE 1 AT DEPTH 4 M**

Total wt of sample =		248.2 gm				
Sieve size	Wt. of Sieve	Wt. of Sieve + soil	Wt. of soil	Percent retained	Cumulative retained	Percent finer
mm	gm	gm	gm	(%)	(%)	(%)
4.75	424.2	459.2	35	14.10	14.10	85.90
2.36	377.8	382.6	4.8	1.93	16.04	83.96
1.18	342	345	3	1.21	17.24	82.76
0.6	363.8	416.4	52.6	21.19	38.44	61.56
0.425	321.4	333.4	12	4.83	43.27	56.73
0.3	345.6	359	13.4	5.40	48.67	51.33
0.15	346.2	462.8	116.6	46.98	95.65	4.35
0.075	338	344.6	6.6	2.66	98.31	1.69

PAN

4.2

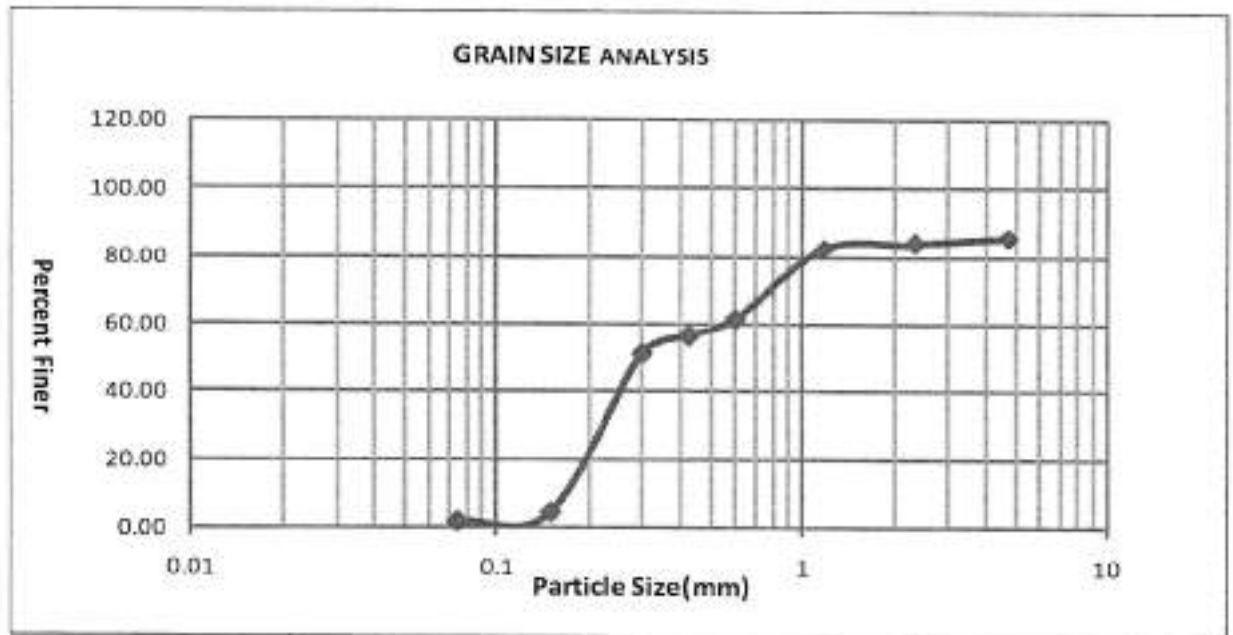

CLAY %	SILT %	SAND %			GRAVEL %
		FINE %	MEDIUM %	COARSE %	
0	1.69	55.04	27.24	1.93	14.10

100

Uniformity Co-efficient(Cu) =	D60/D10	3.23
Co-efficient of Curvature(Cc) =	(D30) <sup>2</sup> /(D60*D10)	0.59
<b>SOIL IS POORLY GRADED SANDY SOIL</b>		



### GRAIN SIZE ANALYSIS OF BORE HOLE 2 AT DEPTH 4 M

Total wt of sample 233.2 gm

Sieve size	Wt. of Sieve	Wt. of Sieve + soil	Wt. of soil	Percent retained	Cumulative percent retained	Percent finer
mm	gm	gm	gm	(%)	(%)	(%)
4.75	424.2	436.8	12.6	5.40	5.40	94.60
2.36	377.8	380	2.2	0.94	6.35	93.65
1.18	342	344.6	2.6	1.11	7.46	92.54
0.6	363.8	438	74.2	31.82	39.28	60.72
0.425	321.4	335.2	13.8	5.92	45.20	54.80
0.3	345.6	357.8	12.2	5.23	50.43	49.57
0.15	346.2	459.6	113.4	48.63	99.06	0.94
0.075	338	340.2	2.2	0.94	100.00	0.00
PAN			0	0.00		

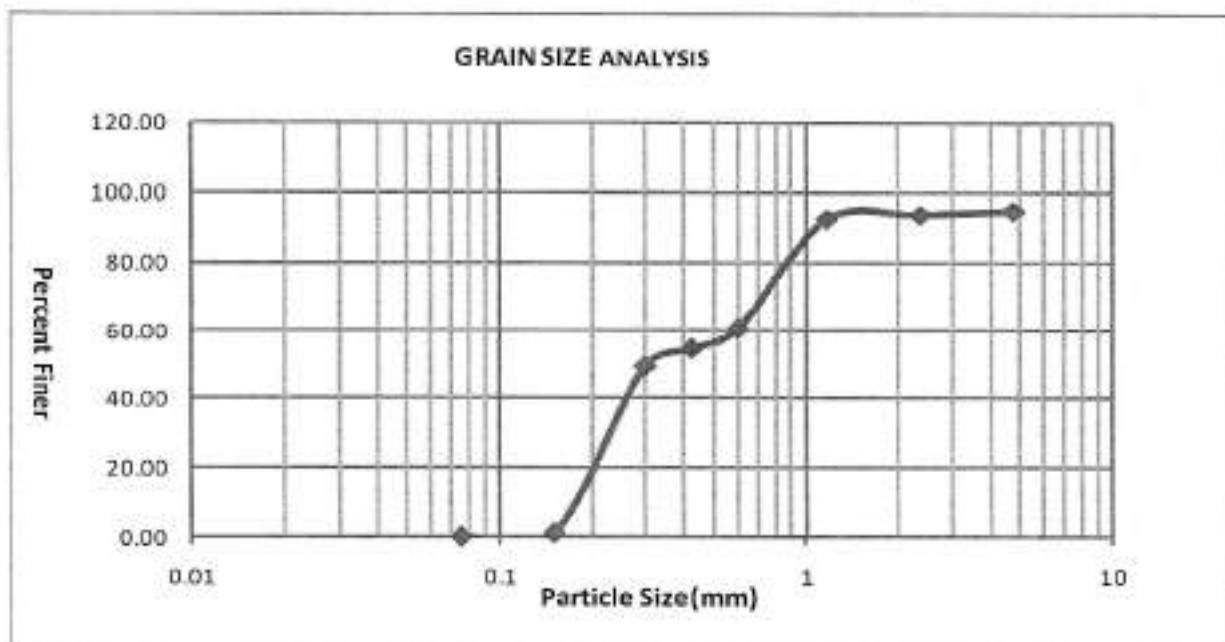

CLAY %	SILT %	SAND %			GRAVEL %
		FINE %	MEDIUM %	COARSE %	
0	0.00	54.80	38.85	0.94	5.40

100

Uniformity Co-efficient(Cu) = D60/D10	3.25
Co-efficient of Curvature(Cc) = (D30) <sup>2</sup> /(D60*D10)	0.56
<b>SOIL IS POORLY GRADED SANDY SOIL</b>	





### GRAIN SIZE ANALYSIS OF BORE HOLE 3 AT DEPTH 4 M

Total wt of sample 240.7 gm

Sieve size	Wt. of Sieve	Wt. of Sieve + soil	Wt. of soil	Percent retained	Cumulative percent retained	Percent finer
mm	gm	gm	gm	(%)	(%)	(%)
4.75	424.2	448	23.8	9.89	9.89	90.11
2.36	377.8	381.3	3.5	1.45	11.34	88.66
1.18	342	344.8	2.8	1.16	12.51	87.49
0.6	363.8	427.2	63.4	26.34	38.85	61.15
0.425	321.4	334.3	12.9	5.36	44.20	55.80
0.3	345.6	358.4	12.8	5.32	49.52	50.48
0.15	346.2	461.2	115	47.78	97.30	2.70
0.075	338	342.4	4.4	1.83	99.13	0.87
PAN			2.1	0.87		

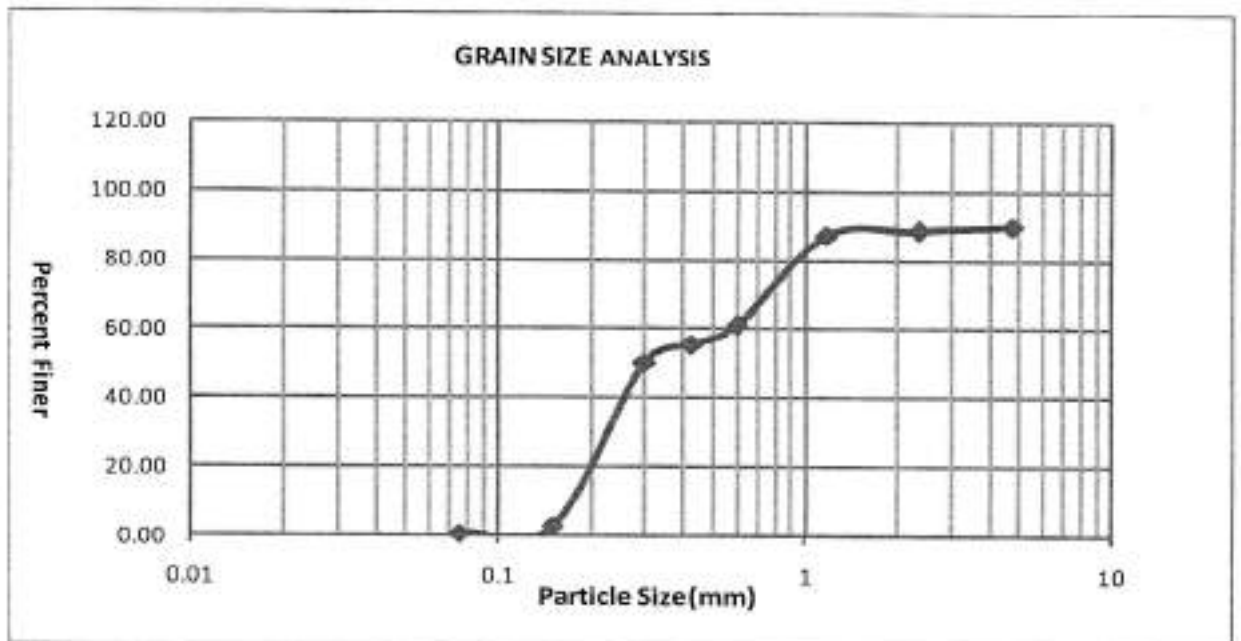

CLAY %	SILT %	SAND %			GRAVEL %
		FINE %	MEDIUM %	COARSE %	
0	0.87	54.92	32.86	1.45	9.89

100

Uniformity Co-efficient(Cu) = D60/D10	D60/D10	3.25
Co-efficient of Curvature(Cc) =	(D30) <sup>2</sup> /(D60*D10)	0.57
<b>SOIL IS POORLY GRADED SANDY SOIL</b>		



### GRAIN SIZE ANALYSIS OF BORE HOLE 4 AT DEPTH 4 M

Total wt of sample		225.5 gm				
Sieve size	Wt. of Sieve	Wt. of Sieve + soil	Wt. of soil	Percent retained	Cumulative percent retained	Percent finer
mm	gm	gm	gm	(%)	(%)	(%)
4.75	424.2	429.9	5.7	2.53	2.53	97.47
2.36	377.8	380.2	2.4	1.06	3.59	96.41
1.18	342	345.5	3.5	1.55	5.14	94.86
0.6	363.8	447.8	84	37.25	42.39	57.61
0.425	321.4	338.3	16.9	7.49	49.89	50.11
0.3	345.6	353.7	8.1	3.59	53.48	46.52
0.15	346.2	442	95.8	42.48	95.96	4.04
0.075	338	344.8	6.8	3.02	98.98	1.02
PAN			2.3	1.02		

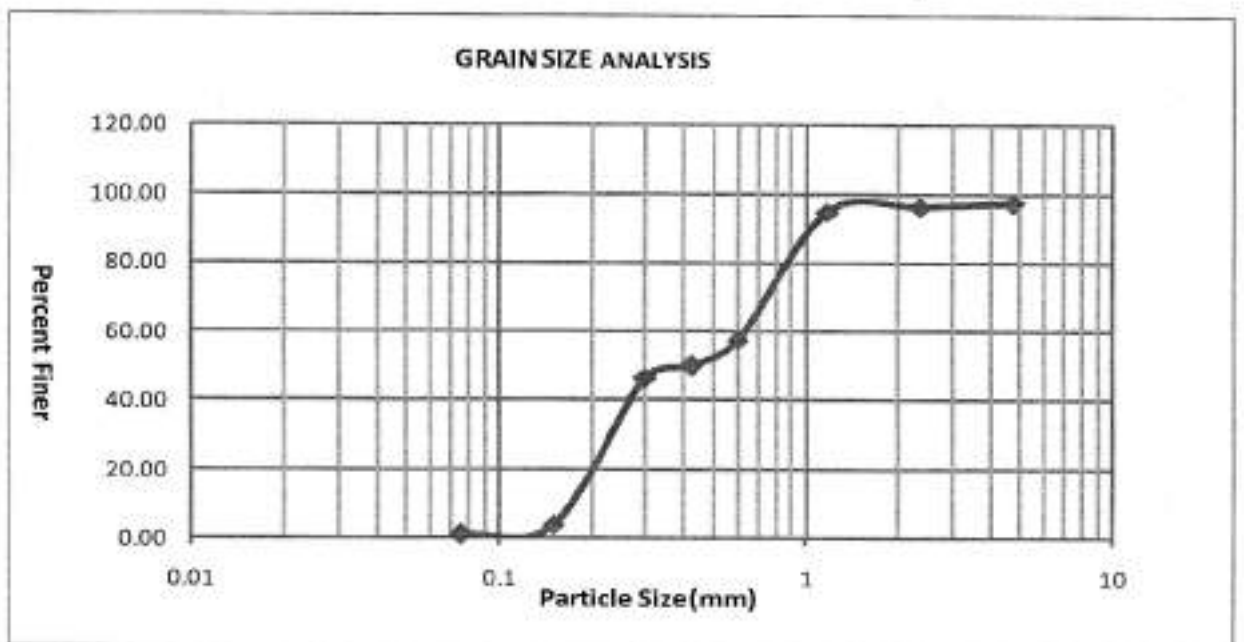

CLAY %	SILT %	SAND %			GRAVEL %
		FINE %	MEDIUM %	COARSE %	
0	1.02	49.09	46.30	1.06	2.53

100

Uniformity Co-efficient(Cu) = D60/D10	D60/D10	3.73
Co-efficient of Curvature(Cc) =	(D30) <sup>2</sup> /(D60*D10)	0.54
<b>SOIL IS POORLY GRADED SANDY SOIL</b>		



### GRAIN SIZE ANALYSIS OF BORE HOLE 5 AT DEPTH 4 M

Total wt of sample 164 gm						
Sieve size	Wt. of Sieve	Wt. of Sieve + soil	Wt. of soil	Percent retained	Cumulative percent retained	Percent finer
mm	gm	gm	gm	(%)	(%)	(%)
4.75	424.2	430.6	6.4	3.90	3.90	96.10
2.36	377.8	383.2	5.4	3.29	7.20	92.80
1.18	342	344.6	2.6	1.59	8.78	91.22
0.6	363.8	436.4	72.6	44.27	53.05	46.95
0.425	321.4	325.2	3.8	2.32	55.37	44.63
0.3	345.6	349.4	3.8	2.32	57.68	42.32
0.15	346.2	411	64.8	39.51	97.20	2.80
0.075	338	342	4	2.44	99.63	0.37
PAN			0.6	0.37		

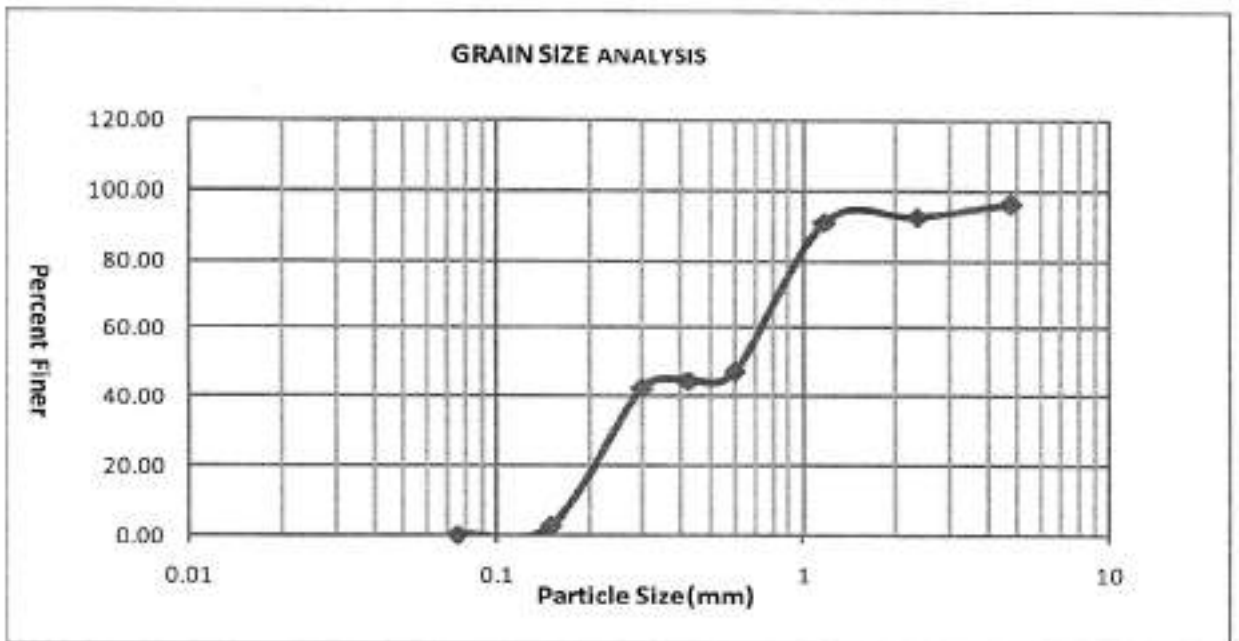

CLAY %	SILT %	SAND %			GRAVEL %
		FINE %	MEDIUM %	COARSE %	
0	0.37	44.27	48.17	3.29	3.90

100

Uniformity Co-efficient(Cu) = D60/D10	D60/D10	4.35
Co-efficient of Curvature(Cc) =	(D30) <sup>2</sup> /(D60*D10)	0.47
<b>SOIL IS POORLY GRADED SANDY SOIL</b>		



### GRAIN SIZE ANALYSIS OF BORE HOLE 6 AT DEPTH 4 M

Total wt of sample 258.3 gm						
Sieve size	Wt. of Sieve	Wt. of Sieve + soil	Wt. of soil	Percent retained	Cumulative percent retained	Percent finer
mm	gm	gm	gm	(%)	(%)	(%)
4.75	424.2	449.1	24.9	9.64	9.64	90.36
2.36	377.8	383.2	5.4	2.09	11.73	88.27
1.18	342	346.8	4.8	1.86	13.59	86.41
0.6	363.8	428.1	64.3	24.89	38.48	61.52
0.425	321.4	335.1	13.7	5.30	43.79	56.21
0.3	345.6	360.1	14.5	5.61	49.40	50.60
0.15	346.2	468.2	122	47.23	96.63	3.37
0.075	338	345.1	7.1	2.75	99.38	0.62
PAN			1.6	0.62		

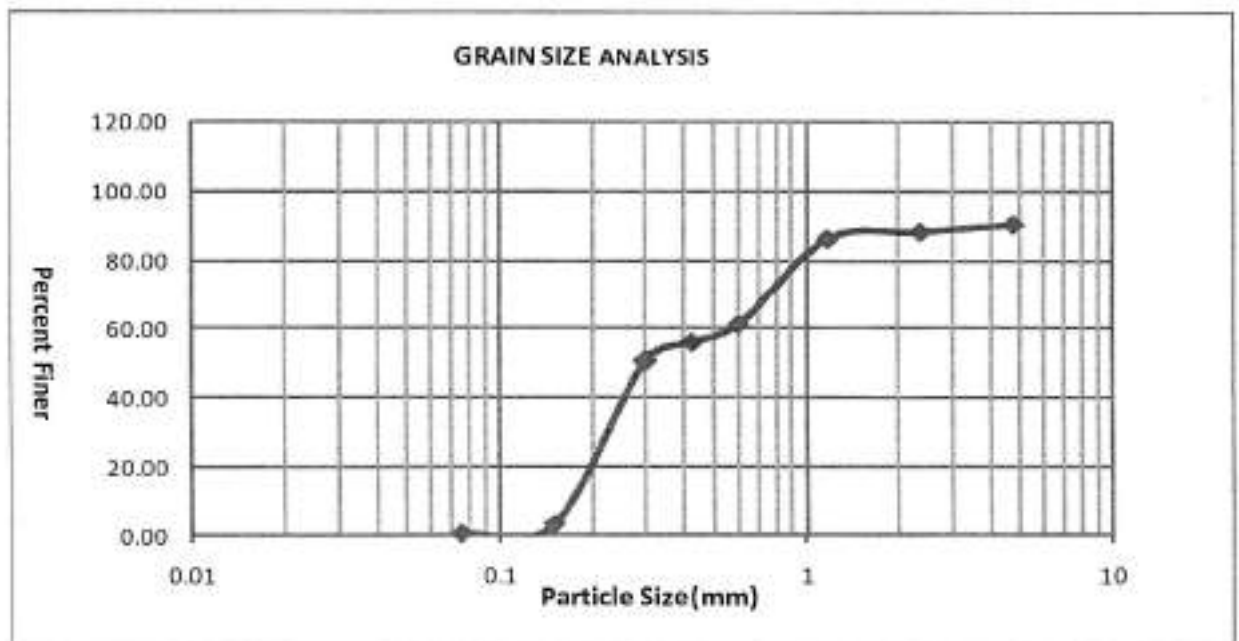

CLAY %	SILT %	SAND %			GRAVEL %
		FINE %	MEDIUM %	COARSE %	
0	0.62	55.59	32.06	2.09	9.64

100

Uniformity Co-efficient(Cu) = D60/D10	D60/D10	3.21
Co-efficient of Curvature(Cc) =	(D30) <sup>2</sup> /(D60*D10)	0.58
SOIL IS POORLY GRADED SANDY SOIL		



### GRAIN SIZE ANALYSIS OF BORE HOLE 7 AT DEPTH 4 M

Total wt of sample 246.9 gm

Sieve size	Wt. of Sieve	Wt. of Sieve + soil	Wt. of soil	Percent retained	Cumulative percent retained	Percent finer
mm	gm	gm	gm	(%)	(%)	(%)
4.75	424.2	431.9	7.7	3.12	3.12	96.88
2.36	377.8	382.2	4.4	1.78	4.90	95.10
1.18	342	348.5	6.5	2.63	7.53	92.47
0.6	363.8	449.8	86	34.83	42.37	57.63
0.425	321.4	341.3	19.9	8.06	50.43	49.57
0.3	345.6	355.7	10.1	4.09	54.52	45.48
0.15	346.2	445	98.8	40.02	94.53	5.47
0.075	338	346.8	8.8	3.56	98.10	1.90
PAN			4.7	1.90		

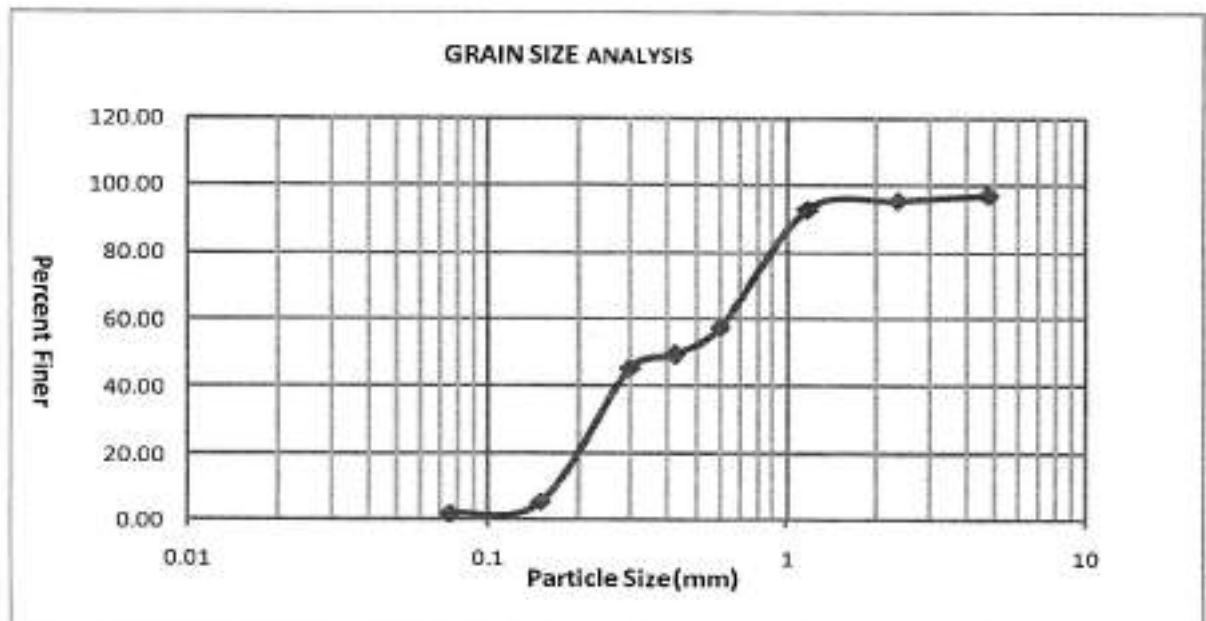

CLAY %	SILT %	SAND %			GRAVEL %
		FINE %	MEDIUM %	COARSE %	
0	1.90	47.67	45.52	1.78	3.12

100

Uniformity Co-efficient(Cu) = D60/D10	D60/D10	3.83
Co-efficient of Curvature(Cc) =	(D30) <sup>2</sup> /(D60*D10)	0.55
SOIL IS POORLY GRADED SANDY SOIL		



**Table-8**

ESTIMATED PHYSICAL PROPERTIES OF SOIL					
Depth	2	3	4	5	6
Bulk Density, $\gamma_{bulk}(t/m^3)$	1.79	1.79	1.79	1.878	1.96
Natural Moisture content, w(%)	23.4	27.67	26.23	28.58	28.92
Natural dry density, $\gamma_{dry}(t/m^3)$	1.45	1.40	1.42	1.46	1.52
Specific Gravity, G	2.64	2.64	2.64	2.64	2.64
Void Ratio, e	0.82	0.88	0.86	0.81	0.74
Saturated density, $\gamma_{sat}(t/m^3)$	1.90	1.87	1.88	1.91	1.94
Submerged Density $\gamma_{sub}(t/m^3)$	0.90	0.87	0.88	0.91	0.94
Angle of Internal Friction( $\phi$ )	31.90	31.35	30.97	31.03	30.89
Angle of Internal Friction( $\phi'$ )	22.64	22.20	21.90	21.95	21.84



**Table-9**

SPT(N) VALUE CORRECTION							
Depth(M)	Ybulk (gm /cc)	EOP	(C <sub>n</sub> )	N	N'	N''	Design N Value
2	1.79	0.358	1.34	13	17.45	16.22	15.70
3	1.79	0.537	1.19	15	17.78	16.39	14.04
4	1.79	0.716	1.11	15	16.70	15.85	12.90
5	1.878	0.939	1.02	14	14.34	14.34	13.09
6	1.96	1.176	0.96	10	9.58	9.58	12.67
7	1.96	1.372	0.91	13	11.84	11.84	14.22
8	1.96	1.568	0.87	21	18.19	16.60	

N = Field N Value (Minimum of all bore holes)

N' = N Value after overburden correction

N'' = N Value after Dilatancy correction

EOP = Effective overburden pressure

C<sub>n</sub> = Overburden correction



**Table-10**

<b>Calculation of Net Safe Bearing Capacity as per IS-6403:1981, Based on <u>General Shear Failure</u> with <math>\phi</math> determined from Design 'N' value, derived from corrected field N value as per IS- 2131:1981.</b>						
Width (B in metre)	6	6	6	6	6	6
Submerged Density of Soil(t/m <sup>3</sup> )	0.88	0.88	0.91	0.91	0.94	0.94
Saturated Density of soil(t/m <sup>3</sup> )	1.88	1.88	1.91	1.91	1.94	1.94
Depth(D in metre)	4	4	5	5	6	6
Surcharge (q in t/ m <sup>2</sup> )	3.52	3.52	4.54	4.54	5.67	5.67
$\phi$ ( degree )	30.97	30.97	31.03	31.03	30.89	30.89
Water table correction( $w^1$ )	0.5	0.5	0.5	0.5	0.5	0.5
Shape factors						
sq	1.2	1.2	1.2	1.2	1.2	1.2
$s_\gamma$	0.8	0.8	0.8	0.8	0.8	0.8
Depth factors						
$d_q$	1.12	1.12	1.15	1.15	1.17	1.17
$d_\gamma$	1.12	1.12	1.15	1.15	1.17	1.17
Inclination factors						
$i_q$	1	1	1	1	1	1
$i_\gamma$	1	1	1	1	1	1
Bearing capacity factors						
$N_q$	21.28	21.28	21.47	21.47	21.05	21.05
$N_\gamma$	27.36	27.36	27.68	27.68	26.96	26.96
$q.(N_q - 1).s_q.d_q.i_q$ (t/m <sup>2</sup> )	96.06	96.06	128.14	128.14	159.55	159.55
$0.5.B.\gamma_{sub}.N_\gamma.s_\gamma.d_\gamma.i_\gamma.w^1$ (t/m <sup>2</sup> )	32.39	32.39	34.66	34.66	35.75	35.75
Ultimate net bearing capacity(t/m <sup>2</sup> )	128.45	128.45	162.80	162.80	195.30	195.3
Factor of safety	3	3	3	3	3	3
Net safe bearing capacity(t/m <sup>2</sup> )	42.82	42.82	54.27	54.27	65.10	65.10





**Table-11**

<b>Calculation of Net Safe Bearing Capacity as per IS-6403:1981, Based on Local Shear Failure with <math>\phi'</math> determined from Design 'N' value, derived from corrected field N value as per IS- 2131:1981.</b>						
Width (B in metre)	6	6	6	6	6	6
Submerged Density of Soil(t/m <sup>3</sup> )	0.88	0.88	0.91	0.91	0.94	0.94
Saturated Density of soil(t/m <sup>3</sup> )	1.88	1.88	1.91	1.91	1.94	1.94
Depth(D in metre)	4	4	5	5	6	6
Surcharge (q in t/ m <sup>2</sup> )	3.52	3.52	4.54	4.54	5.67	5.67
$\phi'$ ( degree )	21.90	21.90	21.95	21.95	21.84	21.84
Water table correction( $w^j$ )	0.5	0.5	0.5	0.5	0.5	0.5
Shape factors						
sq	1.2	1.2	1.2	1.2	1.2	1.2
$s_y$	0.8	0.8	0.8	0.8	0.8	0.8
Depth factors						
$d_q$	1.12	1.12	1.15	1.15	1.17	1.17
$d_y$	1.12	1.12	1.15	1.15	1.17	1.17
Inclination factors						
$i_q$	1	1	1	1	1	1
$i_y$	1	1	1	1	1	1
Bearing capacity factors						
$N'_q$	8.02	8.02	8.06	8.06	7.97	7.97
$N'_y$	7.48	7.48	7.53	7.53	7.41	7.41
$q \cdot (N'_q - 1) \cdot s_q \cdot d_q \cdot i_q$ (t/m <sup>2</sup> )	33.25	33.25	44.22	44.22	55.45	55.45
$0.5 \cdot B \cdot \gamma_{sub} \cdot N'_y \cdot s_y \cdot d_y \cdot i_y \cdot w^j$ (t/m <sup>2</sup> )	8.86	8.86	9.43	9.43	9.83	9.83
Ultimate net bearing capacity(t/m <sup>2</sup> )	42.11	42.11	53.65	53.65	65.28	65.283
Factor of safety	3	3	3	3	3	3
Net safe bearing capacity(t/m <sup>2</sup> )	14.04	14.04	17.88	17.88	21.76	21.76



**Table-12**

**Summary Table of calculation of Net Safe Net Safe Bearing Capacities based on Shear Failure and settlement criteria as per codal provisions based on which suggested net safe bearing capacity has been recommended.**

Depth	Width(B) Metre	Length (L)	Net Safe Bearing Capacity Based on General Shear Failure (t/m <sup>2</sup> )	Net Safe Bearing Capacity Based on Local Shear Failure(t/m <sup>2</sup> )	Void Ratio	Net Safe Bearing Capacity Based on Void Ratio(t/ m <sup>2</sup> )	Net Safe Bearing Capacity Based on Allowable Settlement (25 to 50mm)(t/ m <sup>2</sup> )	Suggested Net Safe Bearing Capacity (t/m <sup>2</sup> )
6 Metre Raft	6	6	65.10	21.76	0.74	24.69	21.92	21.92

**Recommendations**

1. Above recommendations are made for RAFT TYPE footings of mentioned minimum sizes and depth.
2. Raft type footing is recommended at a minimum depth of 6m.
3. Inconsistent soil (specially in areas under the influence of BH-4&5) at depth between 6m and 7m should be removed and replaced with well compacted good sand.
4. Geotechnical Engineer to be consulted in case of any doubt.

Checked by:-



Surajit Chatterjee  
B.E. (Civil), M.I.E.  
Chartered Engineer  
Geo-Technical Engineer, Class-I  
SMC ampanelment Number-07  
Hospital More, Near Children Park,  
Siliguri-734001, Ph-9434020092  
E-mail:chatterjee\_abc@yahoo.co.in

Prepared by:-



AVIJIT GHOSH (B. Tech)  
Geo-Technical Engineer



---

**PHOTOGRAPH**

